

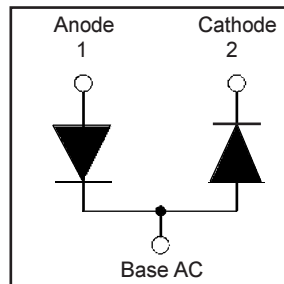
## HFA280NJ60D

HEXFRED™

Ultrafast, Soft Recovery Diode

### Features

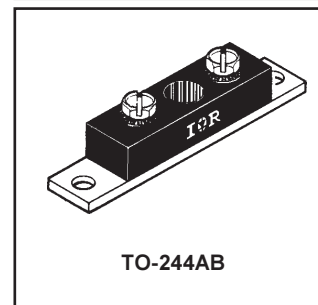
- Reduced RFI and EMI
- Reduced Snubbing
- Extensive Characterization of Recovery Parameters



$V_R = 600V$
$V_F(\text{typ.})^{\textcircled{3}} = 1.3V$
$I_{F(AV)} = 280A$
$Q_{rr}(\text{typ.}) = 490nC$
$I_{RRM}(\text{typ.}) = 9.3A$
$t_{rr}(\text{typ.}) = 39ns$
$di_{(rec)M}/dt(\text{typ.})^{\textcircled{3}} = 200A/\mu s$

### Description

HEXFRED™ diodes are optimized to reduce losses and EMI/RFI in high frequency power conditioning systems. An extensive characterization of the recovery behavior for different values of current, temperature and di/dt simplifies the calculations of losses in the operating conditions. The softness of the recovery eliminates the need for a snubber in most applications. These devices are ideally suited for power converters, motors drives and other applications where switching losses are significant portion of the total losses.



### Absolute Maximum Ratings (per Leg)

	Parameter	Max.	Units
$V_R$	Cathode-to-Anode Voltage	600	V
$I_F @ T_C = 25^\circ C$	Continuous Forward Current	222	A
$I_F @ T_C = 100^\circ C$	Continuous Forward Current	111	
$I_{FSM}$	Single Pulse Forward Current <sup>①</sup>	800	
$E_{AS}$	Non-Repetitive Avalanche Energy <sup>②</sup>	220	$\mu J$
$P_D @ T_C = 25^\circ C$	Maximum Power Dissipation	625	W
$P_D @ T_C = 100^\circ C$	Maximum Power Dissipation	250	
$T_J$ $T_{STG}$	Operating Junction and Storage Temperature Range	-55 to +150	C

### Thermal - Mechanical Characteristics

	Parameter	Min.	Typ.	Max.	Units
$R_{thJC}$	Junction-to-Case, Single Leg Conducting	—	—	0.24	$^\circ C/W$ K/W
	Junction-to-Case, Both Legs Conducting	—	—	0.12	
$R_{thCS}$	Case-to-Sink, Flat, Greased Surface	—	0.10	—	
$Wt$	Weight	—	79 (2.8)	—	g (oz)
	Mounting Torque <sup>④</sup>	30 (3.4)	—	40 (4.6)	lbf•in (N•m)
	Mounting Torque Center Hole	12 (1.4)	—	18 (2.1)	
	Terminal Torque	30 (3.4)	—	40 (4.6)	
	Vertical Pull	—	—	80	lbf•in
	2 inch Lever Pull	—	—	35	

**Note:** <sup>①</sup> Limited by junction temperature  
<sup>②</sup>  $L = 100\mu H$ , duty cycle limited by max  $T_J$   
<sup>③</sup>  $125^\circ C$

<sup>④</sup> Mounting surface must be smooth, flat, free of burrs or other protrusions. Apply a thin even film of thermal grease to mounting surface. Gradually tighten each mounting bolt in 5-10 lbf•in steps until desired or maximum torque limits are reached. Module

# HFA280NJ60D

PD-2.516 rev. A 02/99

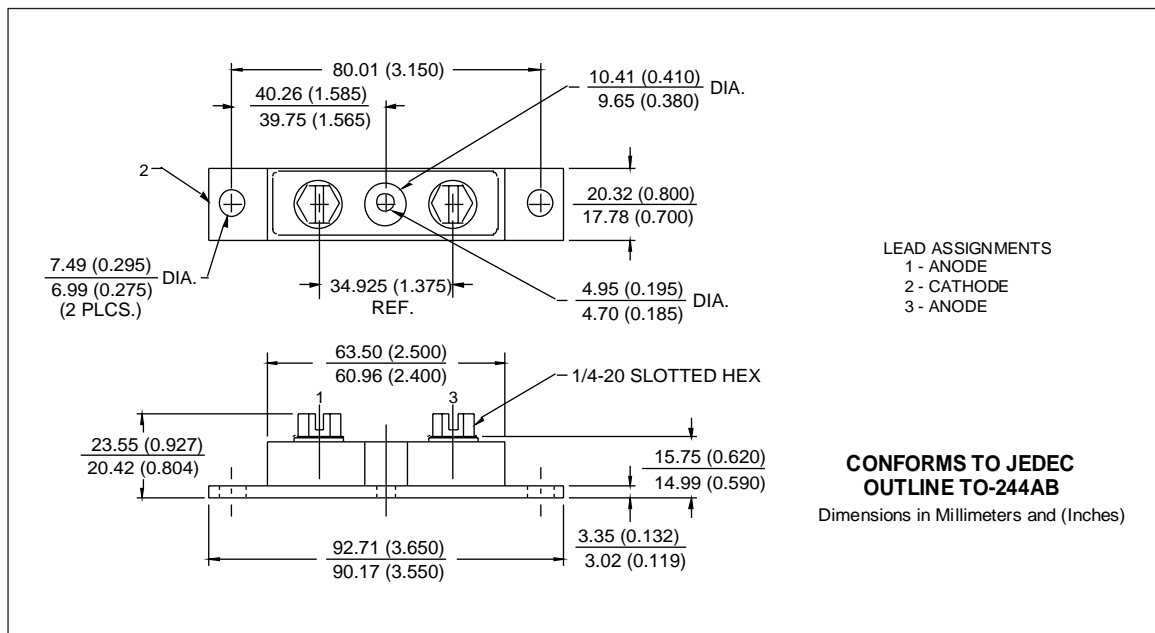
International  
**IOR** Rectifier

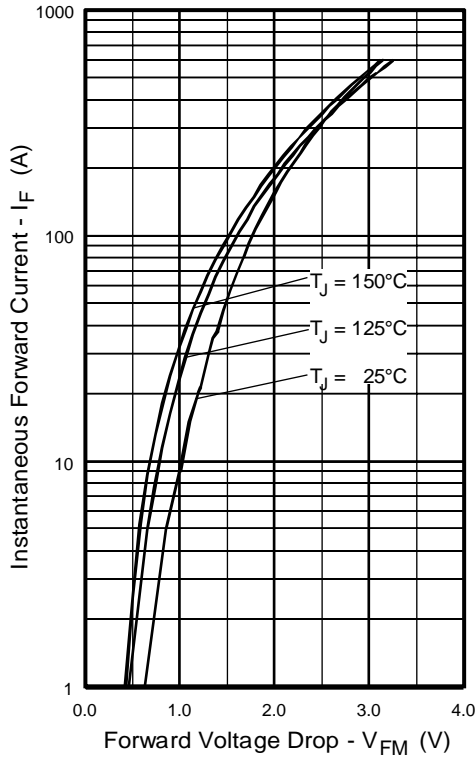
## Electrical Characteristics (per Leg) @ $T_J = 25^\circ\text{C}$ (unless otherwise specified)

Parameter	Min.	Typ.	Max.	Units	Test Conditions
$V_{BR}$ Cathode Anode Breakdown Voltage	600	—	—	V	$I_R = 100\mu\text{A}$
$V_{FM}$ Max Forward Voltage	—	1.4	1.6	V	$I_F = 140\text{A}$ See Fig. 1
	—	1.6	1.8		
	—	1.3	1.5		
$I_{RM}$ Max Reverse Leakage Current	—	8.0	40	$\mu\text{A}$	$V_R = V_R$ Rated See Fig. 2
	—	2.0	8.0	$\text{mA}$	$T_J = 125^\circ\text{C}$ , $V_R = 480\text{V}$
$C_T$ Junction Capacitance	—	280	400	$\text{pF}$	$V_R = 200\text{V}$ See Fig. 3
$L_S$ Series Inductance	—	5.0	—	$\text{nH}$	From top of terminal hole to mounting plane

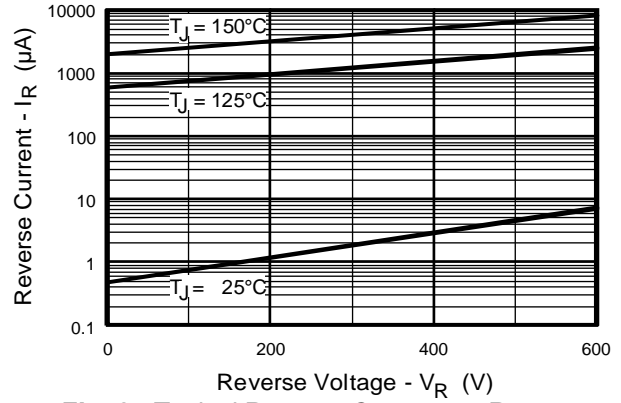
## Dynamic Recovery Characteristics (per Leg) @ $T_J = 25^\circ\text{C}$ (unless otherwise specified)

Parameter	Min.	Typ.	Max.	Units	Test Conditions
$t_{rr}$ Reverse Recovery Time	—	39	—	ns	$I_F = 1.0\text{A}$ , $di_f/dt = 200\text{A}/\mu\text{s}$ , $V_R = 30\text{V}$ $T_J = 25^\circ\text{C}$ $T_J = 125^\circ\text{C}$
$t_{rr1}$	—	92	140		
$t_{rr2}$	—	180	270		
$I_{RRM1}$ Peak Recovery Current	—	9.3	17	A	$T_J = 25^\circ\text{C}$ $T_J = 125^\circ\text{C}$ $V_R = 200\text{V}$
	$I_{RRM2}$	—	16		
$Q_{rr1}$ Reverse Recovery Charge	—	490	1200	nC	$T_J = 25^\circ\text{C}$ $T_J = 125^\circ\text{C}$ $di_f/dt = 200\text{A}/\mu\text{s}$
	$Q_{rr2}$	—	1400		
$di_{(rec)M}/dt1$ Peak Rate of Fall of Recovery Current	—	290	—	$\text{A}/\mu\text{s}$	$T_J = 25^\circ\text{C}$ $T_J = 125^\circ\text{C}$
$di_{(rec)M}/dt2$ During $t_b$	—	200	—		

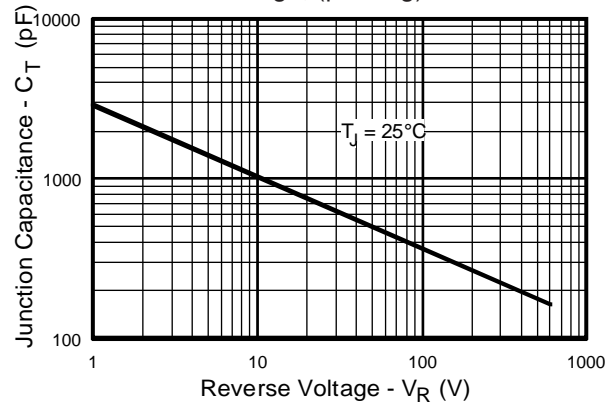




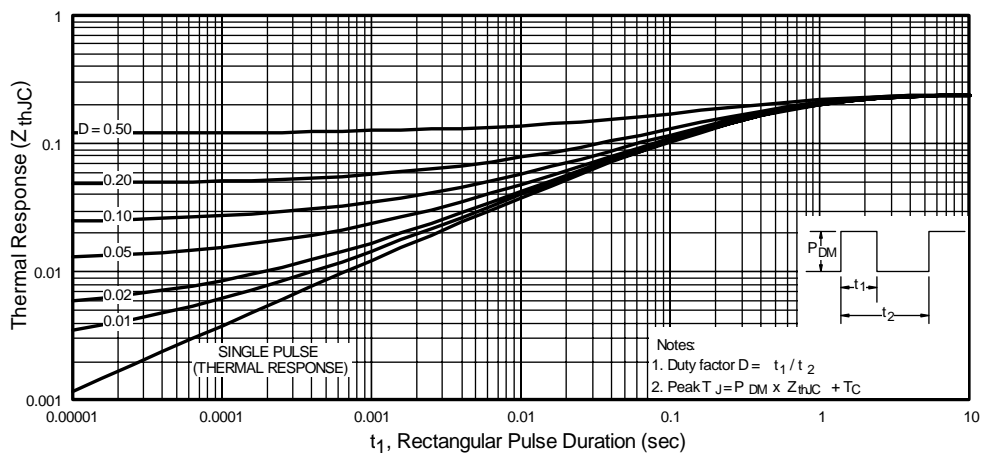
**Fig. 1 - Maximum Forward Voltage Drop vs. Instantaneous Forward Current, (per Leg)**



**Fig. 2 - Typical Reverse Current vs. Reverse Voltage, (per Leg)**



**Fig. 3 - Typical Junction Capacitance vs. Reverse Voltage, (per Leg)**

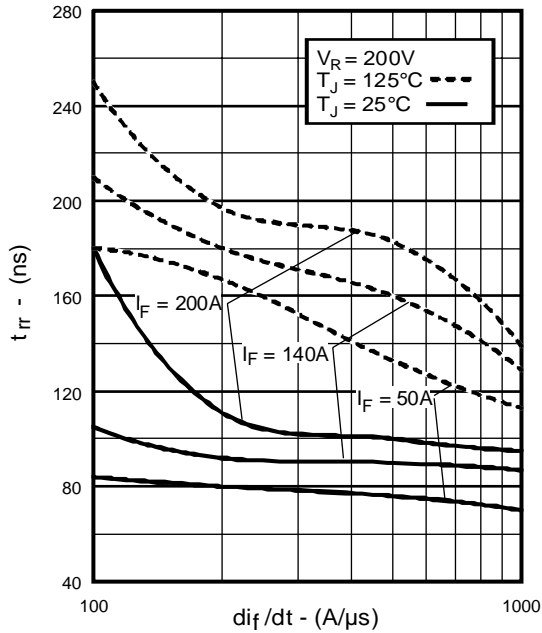


**Fig. 4 - Maximum Thermal Impedance  $Z_{thJC}$  Characteristics, (per Leg)**

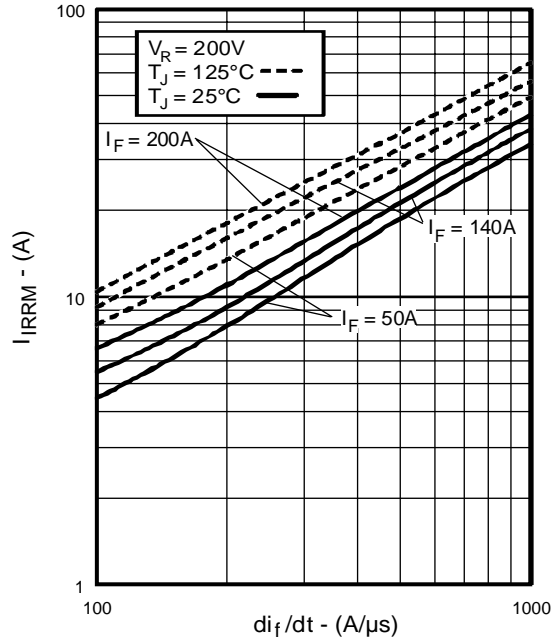
# HFA280NJ60D

PD-2.516 rev. A 02/99

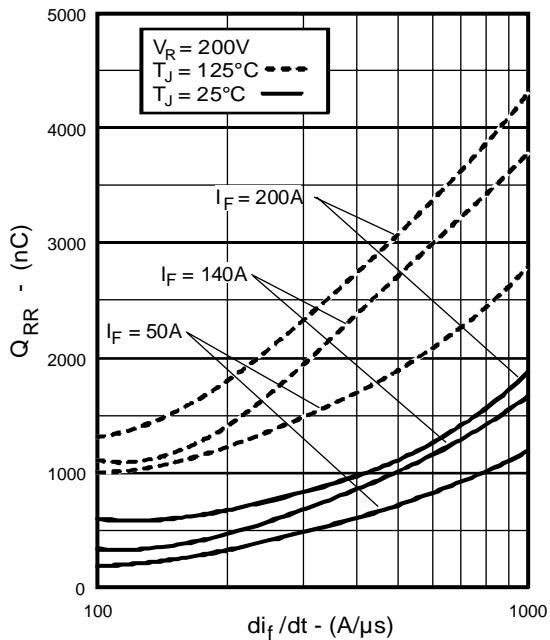
International  
IOR Rectifier



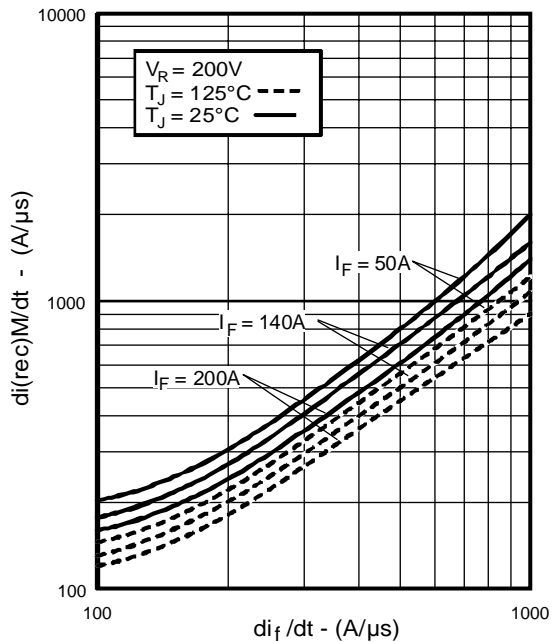
**Fig. 5** - Typical Reverse Recovery vs.  $di_f/dt$ , (per Leg)



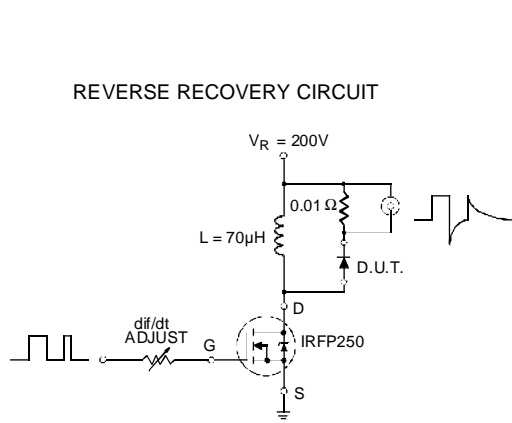
**Fig. 6** - Typical Recovery Current vs.  $di_f/dt$ , (per Leg)



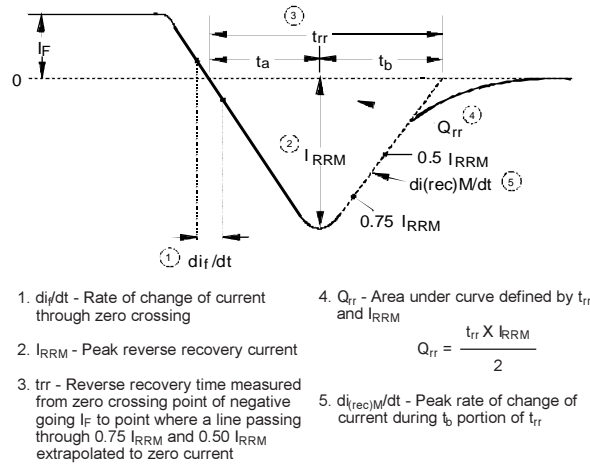
**Fig. 7** - Typical Stored Charge vs.  $di_f/dt$ , (per Leg)



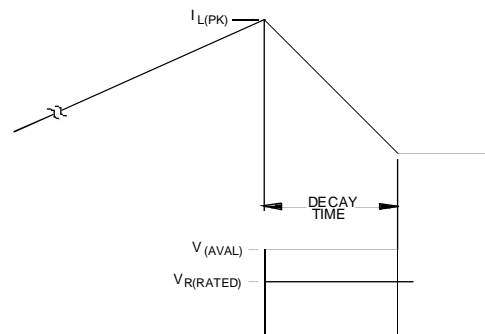
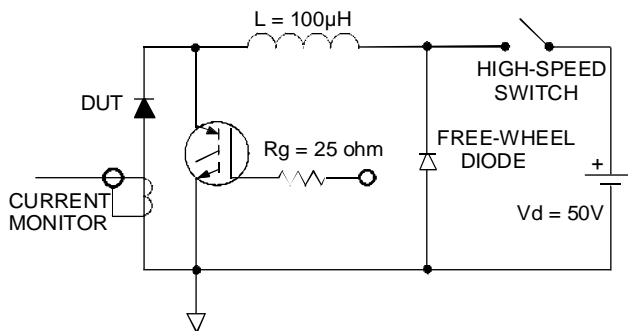
**Fig. 8** - Typical  $di_{(rec)M}/dt$  vs.  $di_f/dt$ , (per Leg)



**Fig. 9** - Reverse Recovery Parameter Test Circuit



**Fig. 10** - Reverse Recovery Waveform and Definitions



**Fig. 11** - Avalanche Test Circuit and Waveforms